

PRZEWODY KOMINOWE TYPU DWWŻ

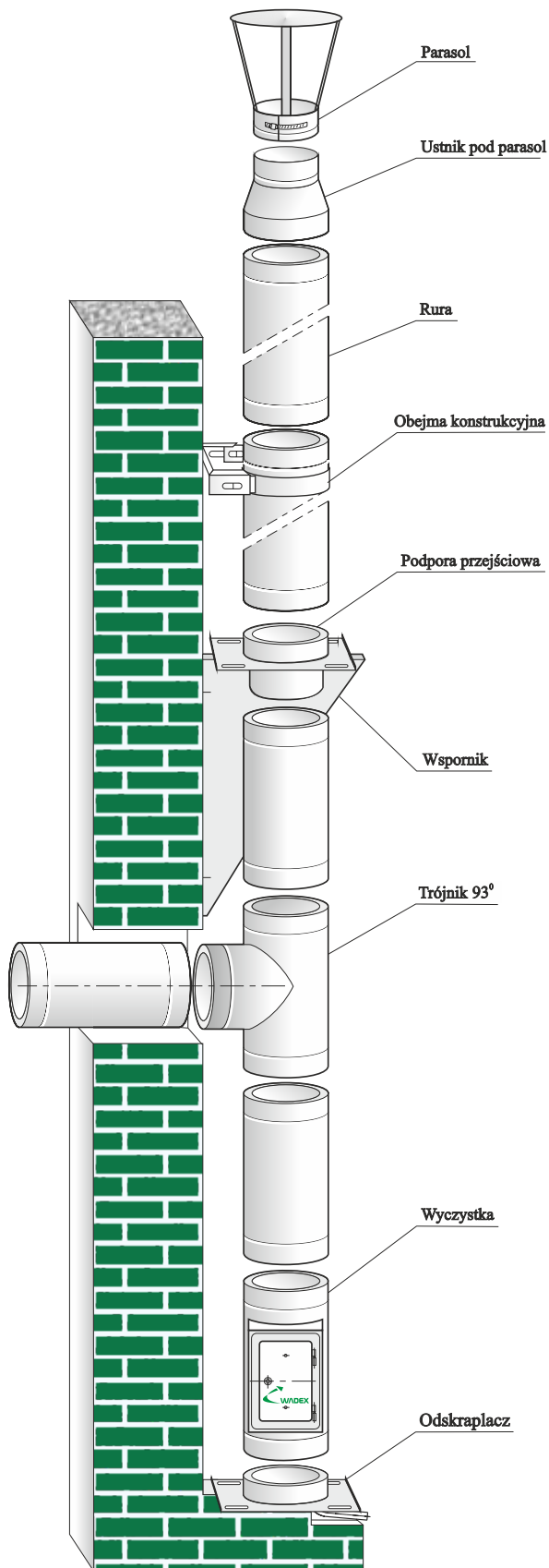

PRZEZNACZENIE:

stosowany jako komin zewnętrzny w celu odprowadzania spalin na zewnątrz budynku z urządzeń grzewczych opalanych drewnem lub ekologicznymi paliwami stałymi o maksymalnej temperaturze spalin 600°C

BUDOWA RUR I KSZTAŁTEK:

elementy dwuścienne izolowane wełną mineralną o grubości 45-50 mm

ZAKRES ŚREDNIC:

130/225 ÷ 400/500 mm

PALIWO:

drewno lub ekologiczne paliwa stałe

GATUNEK I GRUBOŚĆ MATERIAŁU:

stal nierdzewna zaliczana do gatunku żaroodpornych o grubości 1 mm

ODPORNOŚĆ NA KORYZJE:

Vm/V3

ODPORNOŚĆ NA POŻAR SADZY:

odporny

ODLEGŁOŚĆ OD MATERIAŁÓW PALNYCH:

50 mm

KLASA TEMPERATURY:

T 600 - 600°C

SPOSÓB PRACY KOMINA:

podciśnieniowy

ODPORNOŚĆ NA DZIAŁANIE KONDENSATU:

D

D
W
W
Ż

Uwaga: elementy wsporcze, konstrukcyjne i osłonowe z systemu DWW

USTNIK

450

d	D	INDEX
130	225	450130000
150	250	450150000
160	250	450160000
180	270	450180000
200	300	450200000
250	350	450250000
300	400	450300000
350	450	450350000
400	500	450400000

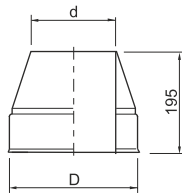

USTNIK POD PARASOL

451

d	D	INDEX
130	225	451130000
150	250	451150000
160	250	451160000
180	270	451180000
200	300	451200000
250	350	451250000
300	400	451300000
350	450	451350000
400	500	451400000

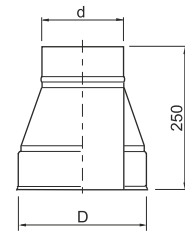

RURA

453, 454, 456

d	D	INDEX		
		L 1000	L 500	L 250
130	225	453130000	454130000	456130000
150	250	453150000	454150000	456150000
160	250	453160000	454160000	456160000
180	270	453180000	454180000	456180000
200	300	453200000	454200000	456200000
250	350	453250000	454250000	456250000
300	400	453300000	454300000	456300000
350	450	453350000	454350000	456350000
400	500	453400000	454400000	456400000

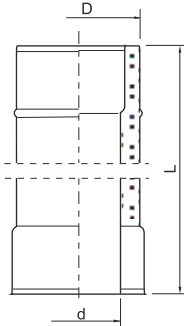

TRÓJNIK 93°

457

d	D	L	INDEX
130	225	450	457130000
150	250	450	457150000
160	250	450	457160000
180	270	500	457180000
200	300	500	457200000
250	350	550	457250000
300	400	600	457300000
350	450	650	457350000
400	500	700	457400000

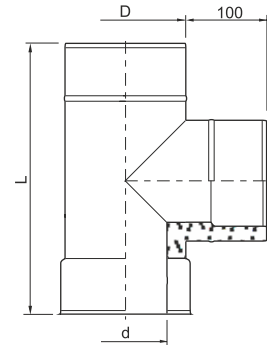

TRÓJNIK 45°

480

d	D	A	L	INDEX
130	225	350	530	480130000
150	250	400	570	480150000
160	250	400	570	480160000
180	270	410	570	480180000
200	300	500	700	480200000
250	350	550	800	480250000
300	400	600	800	480300000
350	450	680	900	480350000
400	500	780	1000	480400000

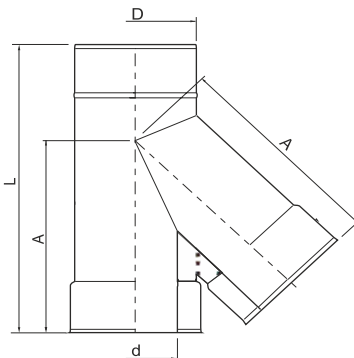

KOLANO 45°

465

d	D	A	INDEX
130	225	140	465130000
150	250	160	465150000
160	250	160	465160000
180	270	155	465180000
200	300	195	465200000
250	350	205	465250000
300	400	215	465300000
350	450	240	465350000
400	500	240	465400000

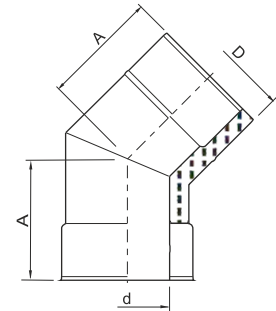

WYCZYSTKA

461

d	D	INDEX
130	225	461130000
150	250	461150000
160	250	461160000
180	270	461180000
200	300	461200000
250	350	461250000
300	400	461300000
350	450	461350000
400	500	461400000

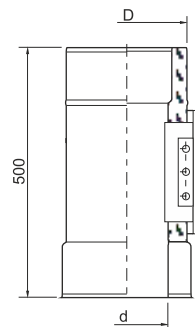

KOLANO 93°

466

d	D	A	INDEX
130	225	200	466130000
150	250	200	466150000
160	250	200	466160000
180	270	200	466180000
200	300	210	466200000
250	350	255	466250000
300	400	295	466300000
350	450	300	466350000
400	500	340	466400000

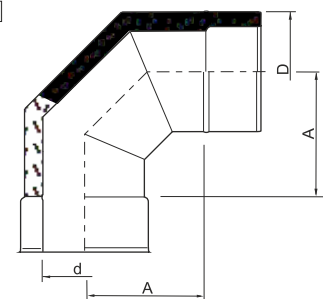

PODPORA PRZEJŚCIOWA

462

d	D	A	INDEX
130	225	300	462130000
150	250	350	462150000
160	250	350	462160000
180	270	350	462180000
200	300	400	462200000
250	350	450	462250000
300	400	500	462300000
350	450	550	462350000
400	500	600	462400000

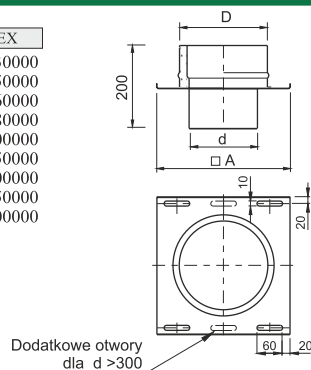

ODSKRAPLACZ

464

d	D	A	INDEX
130	225	300	464130000
150	250	350	464150000
160	250	350	464160000
180	270	400	464180000
200	300	400	464200000
250	350	450	464250000
300	400	500	464300000
350	450	550	464350000
400	500	600	464400000

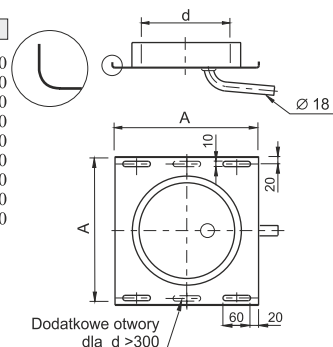

ZAKOŃCZENIE NYPEL - KIELICH 471

d	D	INDEX
130	225	471130000
150	250	471150000
160	250	471160000
180	270	471180000
200	300	471200000
250	350	471250000
300	400	471300000
350	450	471350000
400	500	471400000

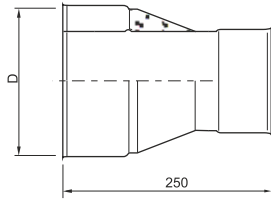

REDUKCJA OWROTNA 476

d	D	INDEX
130	225	476130xzy
150	250	476150xzy
160	250	476160xzy
180	270	476180xzy
200	300	476200xzy
250	350	476250xzy
300	400	476300xzy
350	450	476350xzy
400	500	476400xzy

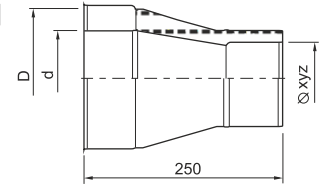

$d > xyz$ $d_{max} = 2 * xyz$

ZAKOŃCZENIE NYPEL - NYPEL 474

d	D	INDEX
130	225	474130000
150	250	474150000
160	250	474160000
180	270	474180000
200	300	474200000
250	350	474250000
300	400	474300000
350	450	474350000
400	500	474400000

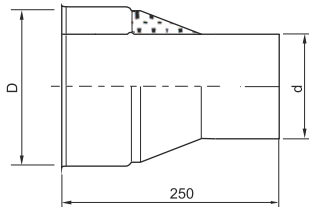

ZAKOŃCZENIE KIELICH - KIELICH 477

d	D	INDEX
130	225	477130000
150	250	477150000
160	250	477160000
180	270	477180000
200	300	477200000
250	350	477250000
300	400	477300000
350	450	477350000
400	500	477400000

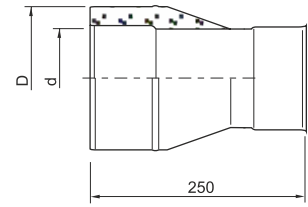

REDUKCJA 475

d	D	INDEX
130	225	475130xzy
150	250	475150xzy
160	250	475160xzy
180	270	475180xzy
200	300	475200xzy
250	350	475250xzy
300	400	475300xzy
350	450	475350xzy
400	500	475400xzy

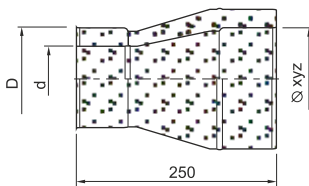

$xyz > d$ $xyz_{max} = 2 * d$

ZAKOŃCZENIE KIELICH - NYPEL 478

d	D	INDEX
130	225	478130000
150	250	478150000
160	250	478160000
180	270	478180000
200	300	478200000
250	350	478250000
300	400	478300000
350	450	478350000
400	500	478400000

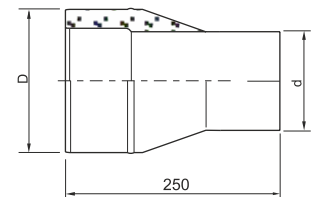

PRZEDŁUŻKA DO KOMINA 463

d	D	A	L	INDEX
130	225	320	1280	463130000
150	250	320	1280	463150000
160	250	320	1280	463160000
180	270	320	1280	463180000
200	300	400	1280	463200000
250	350	450	1280	463250000

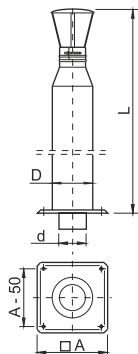

Dla L=1280 indeks jest np.. 463 130 000
a dla L=780 indeks jest 463 130 100

KOLANO Z WYCZYSTKĄ OKRĄGŁĄ 452

d1	d	D	A	INDEX
130	130	225	200	452130000
150	150	250	200	452150000
160	160	250	205	452160000
180	180	270	205	452180000
200	200	300	215	452200000
250	250	350	255	452250000
300	300	400	295	452300000
350	350	450	300	452350000
400	400	500	340	452400000

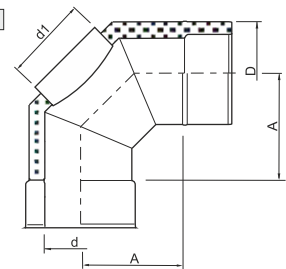

KOLANO 60° 473

d	D	A	INDEX
130	225	140	473130000
150	250	160	473150000
160	250	160	473160000
180	270	170	473180000
200	300	195	473200000
250	350	205	473250000
300	400	215	473300000
350	450	240	473350000
400	500	240	473400000

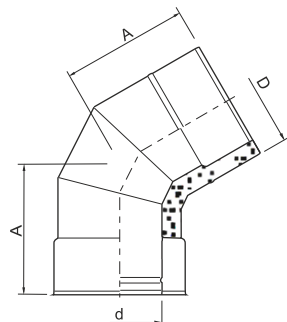

KOLANO 30° 472

d	D	A	INDEX
130	225	140	472130000
150	250	160	472150000
160	250	160	472160000
180	270	155	472180000
200	300	195	472200000
250	350	205	472250000
300	400	215	472300000
350	450	240	472350000
400	500	240	472400000

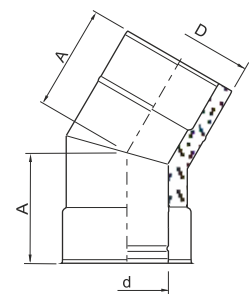

KOLANO 15°

484

d	D	A	INDEX
130	225	140	484130000
150	250	160	484150000
160	250	160	484160000
180	270	155	484180000
200	300	195	484200000
250	350	205	484250000
300	400	215	484300000
350	450	240	484350000
400	500	240	484400000

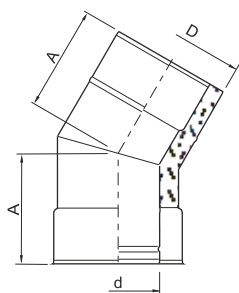

TRÓJNIK 93° Z WYCZYSTKĄ

483

d	D	L	INDEX
130	225	500	483130000
150	250	500	483150000
160	250	500	483160000
180	270	500	483180000
200	300	500	483200000
250	350	550	483250000
300	400	600	483300000
350	450	650	483350000
400	500	700	483400000

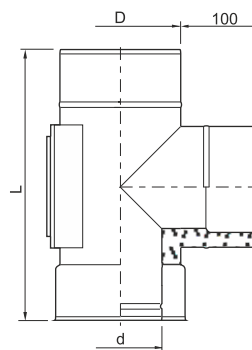

TRÓJNIK REDUKCYJNY 93°

459

d	D	d1	L	INDEX
130	225	400	459130xyz	
150	250	450	459150xyz	
160	250	450	459160xyz	
180	270	450	459180xyz	
200	300	500	459200xyz	
250	350	550	459250xyz	
300	400	600	459300xyz	
350	450	650	459350xyz	
400	500	700	459400xyz	

Zgodnie z zamówieniem

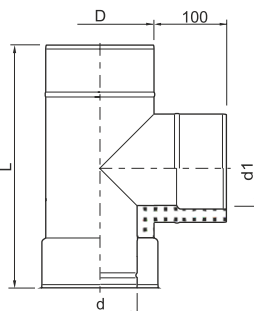

d>d1

TRÓJNIK 45° Z WYCZYSTKĄ

479

d	D	A	L	INDEX
130	225	350	500	479130000
150	250	400	570	479150000
160	250	400	570	479160000
180	270	410	570	479180000
200	300	500	700	479200000
250	350	550	800	479250000
300	400	600	800	479300000
350	450	680	900	479350000
400	500	780	1000	479400000

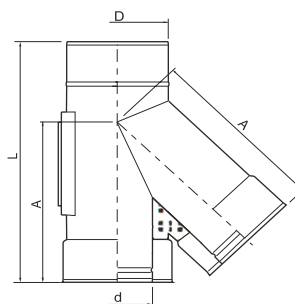

TRÓJNIK REDUKCYJNY 45°

460

d	D	d1	A	L	INDEX
130	225	350	500	460130xyz	
150	250	400	570	460150xyz	
160	250	400	570	460160xyz	
180	270	410	570	460180xyz	
200	300	500	700	460200xyz	
250	350	550	800	460250xyz	
300	400	600	800	460300xyz	
350	450	680	900	460350xyz	
400	500	780	1000	460400xyz	

Zgodnie z zamówieniem

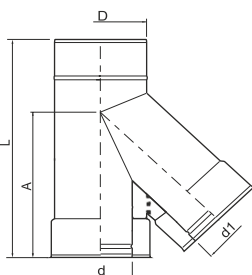

d>d1

REDUKCJA DWUNYFLOWA

482

d	D	INDEX
130	225	482130xyz
150	250	482150xyz
160	250	482160xyz
180	270	482180xyz
200	300	482200xyz
250	350	482250xyz
300	400	482300xyz
350	450	482350xyz
400	500	482400xyz

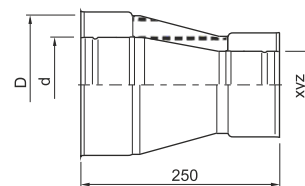

d>xyz d_{max} = 2*xyz

REDUKCJA DWUKIELICHOWA

481

d	D	INDEX
130	225	481130xyz
150	250	481150xyz
160	250	481160xyz
180	270	481180xyz
200	300	481200xyz
250	350	481250xyz
300	400	481300xyz
350	450	481350xyz
400	500	481400xyz

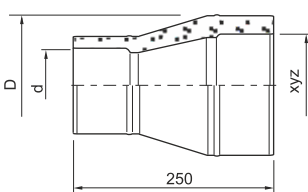

xyz>d xyz_{max} = 2*d

USTNIK POD NASADĘ KOMINOWĄ

451

d	D	INDEX
130	225	451130100
150	250	451150100
160	250	451160100
180	270	451180100
200	300	451200100
250	350	451250100
300	400	451300100
350	450	451350100
400	500	451400100

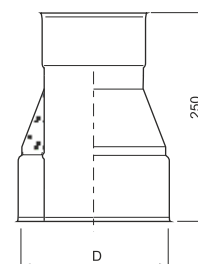

ZAKOŃCZENIE REDUKCYJNE KIELICH - NYPEL 485

d	D	INDEX
130	225	485130xyz5
150	250	485150xyz5
160	250	485160xyz5
180	270	485180xyz5
200	300	485200xyz5
250	350	485250xyz5
300	400	485300xyz5
350	450	485350xyz5
400	500	485400xyz5

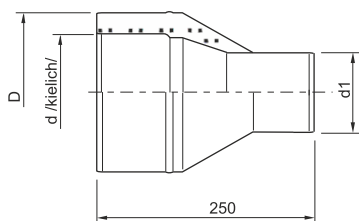

$d > d1$ $d_{max} = 2 * d1$
xyz /d1/ - średnica zgodnie z zamówieniem

ZAKOŃCZENIE REDUKCYJNE NYPEL - NYPEL 487

d	D	INDEX
130	225	487130xyz5
150	250	487150xyz5
160	250	487160xyz5
180	270	487180xyz5
200	300	487200xyz5
250	350	487250xyz5
300	400	487300xyz5
350	450	487350xyz5
400	500	487400xyz5

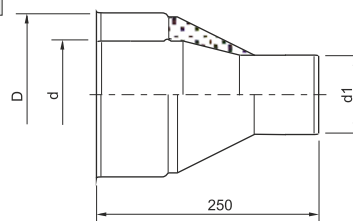

$d > d1$ $d_{max} = 2 * d1$
xyz /d1/ - średnica zgodnie z zamówieniem

ZAKOŃCZENIE REDUKCYJNE KIELICH - KIELICH 486

d	D	INDEX
130	225	486130xyz5
150	250	486150xyz5
160	250	486160xyz5
180	270	486180xyz5
200	300	486200xyz5
250	350	486250xyz5
300	400	486300xyz5
350	450	486350xyz5
400	500	486400xyz5

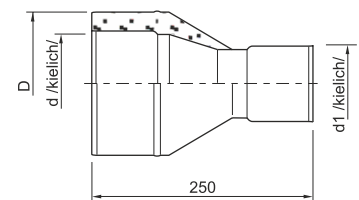

$d > d1$ $d_{max} = 2 * d1$
xyz /d1/ - średnica zgodnie z zamówieniem

ZAKOŃCZENIE REDUKCYJNE NYPEL - KIELICH 488

d	D	INDEX
130	225	488130xyz5
150	250	488150xyz5
160	250	488160xyz5
180	270	488180xyz5
200	300	488200xyz5
250	350	488250xyz5
300	400	488300xyz5
350	450	488350xyz5
400	500	488400xyz5

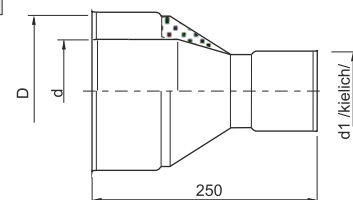

$d > d1$ $d_{max} = 2 * d1$
xyz /d1/ - średnica zgodnie z zamówieniem

D
W
W
Ż

ELEMENT NIETYPOWY

999

Elementy niekatalogowe wykonywane są na podstawie rysunków dostarczonych przez klienta. Wycena takich elementów jest oparta na indywidualnej kalkulacji.